

WAYCONN ELECTRONICS

**MATERIAL:**  
**CAGE:**  
 NICKEL SILVER, THICKNESS 0.25MM  
**CONNECTOR:**  
 PLASTIC HOUSING: HIGH TEMPERATURE LCP, UL94 V-0  
 SPRING: STAINLESS STEEL, THICKNESS 0.20MM  
 CONTACTS: PHOSPHOR BRONZE, THICKNESS 0.20MM  
 PLATING: 15u" MIN. GOLD ON MATING AREA;  
 150u" MIN. MATE TIN ON SOLDER TAILS.  
**PACKING:** TRAY/CARTON  
**TEMPERATURE RANGE:** -40°C ~ 85°C

PRODUCT TITLE:		SFP Cage & Connector 2X1, PRESS-FIT, with 2 Light Pipes	
UNLESS OTHERWISE SPECIFIED TOLERANCES	SCALE: 1/1	UNIT: mm	 SC0-N21PL2-1
	SIZE: A3	PAGE: 1 OF 1	
X :±0.2	X :±1°	<b>WAYCONN ELECTRONICS</b>	
.XX :±0.15	.XX :±5°		
.XXX :±0.1			

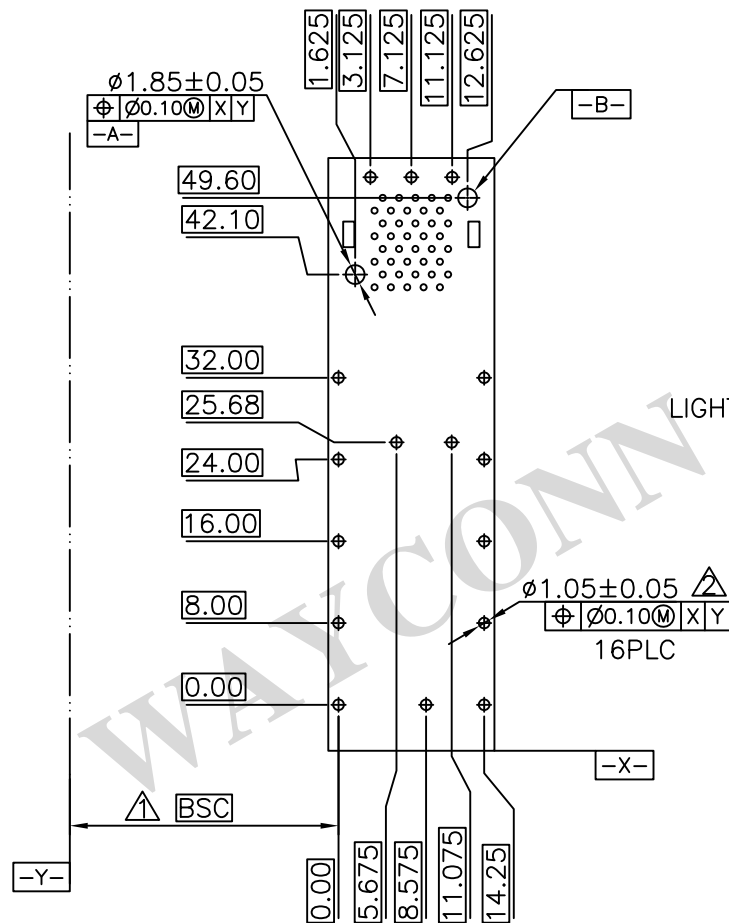

RECOMMENDED PCB CONFIGURATION

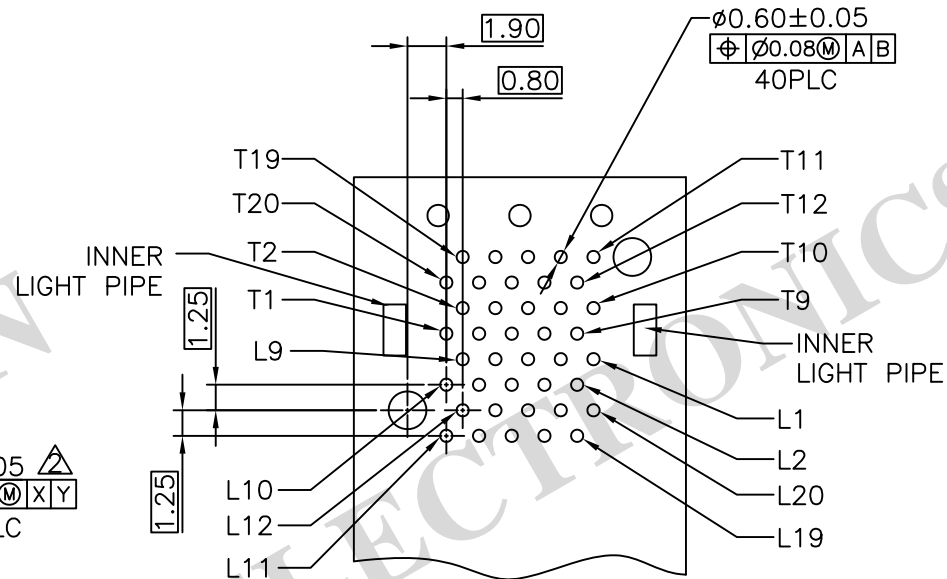

NOTES:

1. DATUM AND BASIC DIMENSIONS ESTABLISHED BY CUSTOMER.
2. 1.05 mm DIAMETER HOLES ARE CHASSIS GROUND .

PRODUCT TITLE:		SFP Cage & Connector 2X1, PRESS-FIT, with 2 Light Pipes	
UNLESS OTHERWISE SPECIFIED TOLERANCES	SCALE: 1/1	UNIT: mm	SC0-N21PL2-1
	SIZE: A3	PAGE: 1 OF 1	RAV.A01
X :±0.2	X :±1°	<b>WAYCONN ELECTRONICS</b>	
.XX :±0.15	.XX :±5°		
.XXX :±0.1			

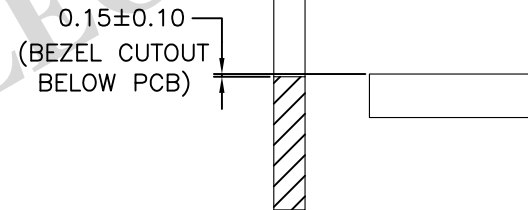
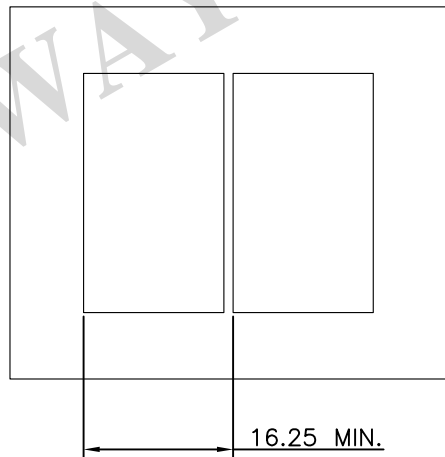
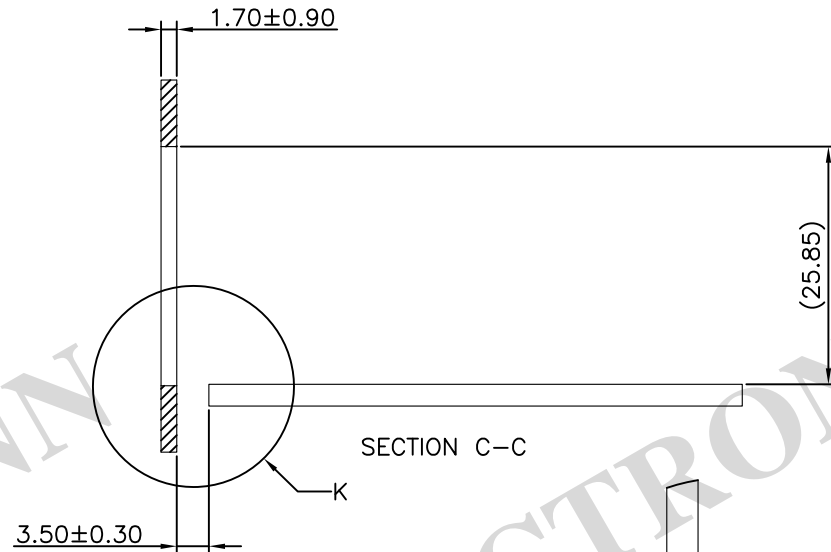
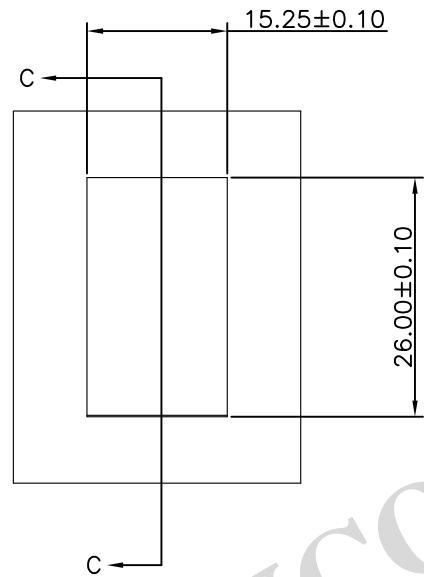

RECOMMENDED BEZEL DESIGN

PRODUCT TITLE:		SFP Cage & Connector 2X1, PRESS-FIT, with 2 Light Pipes		
UNLESS OTHERWISE SPECIFIED TOLERANCES	SCALE: 1/1	UNIT: mm	RAV.A01	SC0-N21PL2-1
	SIZE: A3	PAGE: 1 OF 1	RAV.A01	
X :±0.2	X :±1°	<b>WAYCONN ELECTRONICS</b>		
.XX :±0.15	.XX :±5°			
.XXX :±0.1				