

Mechanical

REV.	DESCRIPTION	DRAWN	CHECKED	APPROVED
A	NEW RELEASE		~	

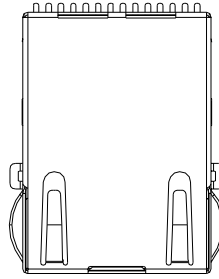

TOP VIEW

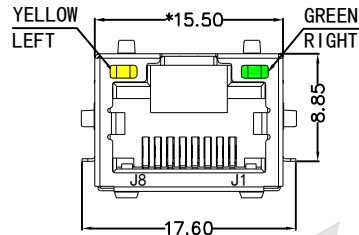

FRONT VIEW

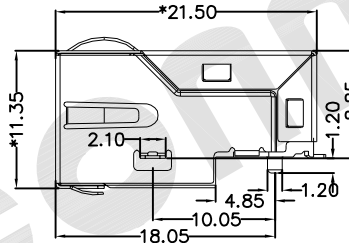

RIGHT SIDE VIEW

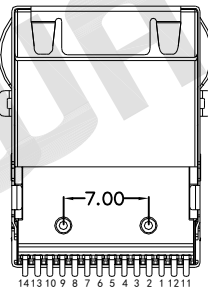

BOTTOM VIEW

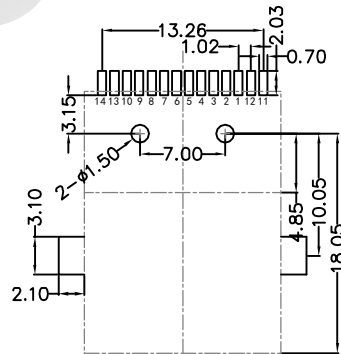

RECOMMENDED PCB LAYOUT
VIEWED FROM COMPONENT SIDE

Material:

Insulator Material: LCP, UL94V-0, Black Shield: 0.20mm Thickness
Copper Alloy, Nickel Plated
Contact Material: Phosphor Bronze 0.35mm
Gold Plating: Selective Gold Plating Over Nickel: 3u", 6u", 15u", 30u"

Mechanical:

Durability: 750 Cycles Min
Matting Force: 22N Max

Environmental:

Storage Temperature : -40°C to +85°C
Operation Temperature: -40°C to +85°C

MJT34 - G8 066 X X X X X X

Shield	Mounting	LED Color	Plastic Peg	Insulator	Gold Plating
0 - w/o Shield	1 - SMT	0 - w/o LED	1 - With	1 - PBT	1 - Fμ"
1 - Shield w/o EMI	2 - DIP	1 - Y/G	2 - Without	2 - PA66	2 - 3μ"
2 - Shield w/ EMI		2 - G/Y		3 - PA46	3 - 6μ"
3 - Half Shield		3 - G/G		4 - LCP	4 - 15μ"
		4 - Y/Y			5 - 30μ"
		5 - Special			6 - 50μ"

GENERAL TOLERANCE	ANGLE TOLERANCE	PROJECTION	TITLE	1000BASE-T, SINK & SMT, TAB-UP, SHIELDED W/ LED & EMI
X. ±0.35	X. ±3.0°	mm		
.X ±0.30	.X ±2.0°			
.XX ±0.25	.XX ±1.5°			
.XXX ±0.10	.XX ±1.0°			
DRAWING TYPE	CUSTOMER	<h1>WAYCONN CO.,LTD</h1>		
SCALE	1:1 SHEET 1 OF 2			
SERIES	MJT34 SERIES			

Schematics

REV.	DESCRIPTION	DRAWN	CHECKED	APPROVED
A	NEW RELEASE			

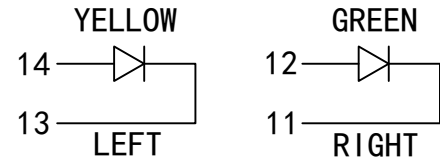
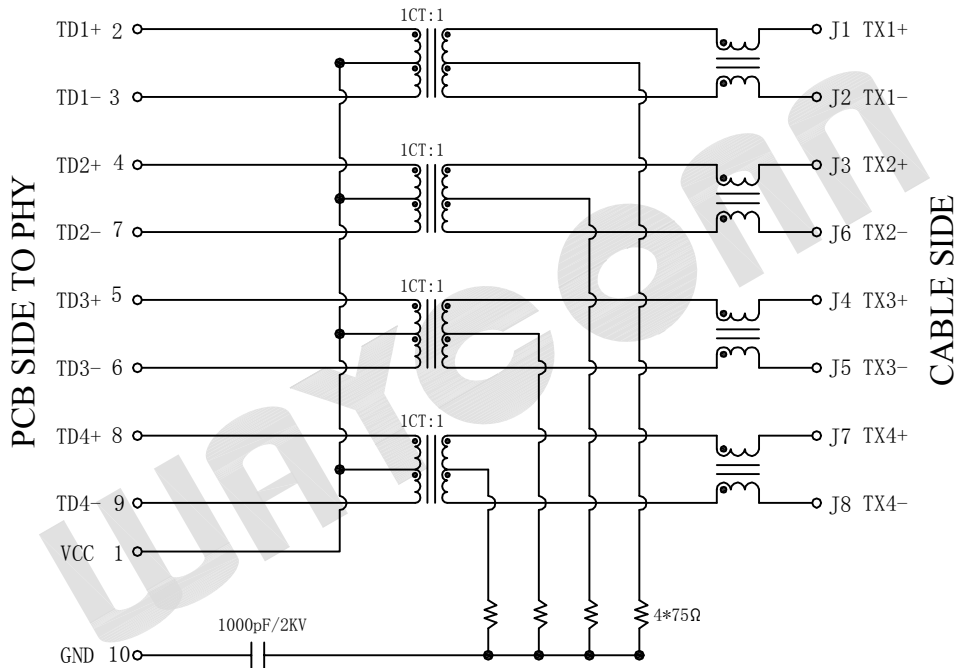

LED Specification

Standard LED Color	LED Wavelength	Foward(A)	Foward(V)
Green	568nm	20mA	1.85-2.45V
Yellow	585nm	20mA	1.7-2.2V

ELECTRICAL SPECIFICATIONS AT 25°C

Turns Ratio (±2%)		Insertion Loss (dB max)	Return Loss (dB max)				Crosstalk (dB TYP)			Common Mode Rejection (dB TYP)	Hipot (vrms)
TX	RX		1~10 MHz	10~30 MHz	30~60 MHz	60~100 MHz	1~30 MHz	30~60 MHz	60~100 MHz		
ICT: ICT	ICT: ICT	-1.0	-20	-16	-12	-10	-40	-35	-30	-30	1500

1. OCL: 350uH minimum with 8mA current;

GENERAL TOLERANCE	ANGLE TOLERANCE	PROJECTION		TITLE	1000BASE-T, SINK & SMT, TAB-UP, SHIELDED W/ LED & EMI	
X. ±0.35	X. ±3.0°	UNITS	mm	PART NO.	MJT34 - G80662114X	
.X ±0.30	.X ±2.0°	<h1>WAYCONN CO.,LTD</h1>				
.XX ±0.25	.XX ±1.5°					
.XXX ±0.10	.XX ±1.0°					
DRAWING TYPE	CUSTOMER					
SCALE	1:1	SHEET				2 OF 2
SERIES	MJT34 SERIES					