

# Mechanical

REV.	DESCRIPTION	DRAWN	CHECKED	APPROVED
A	NEW RELEASE		~	

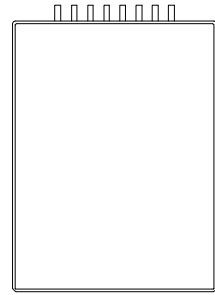

TOP

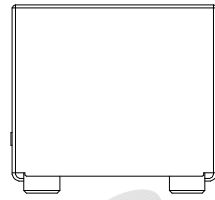

BACK

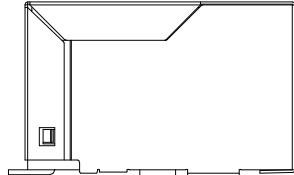

LEFT SIDE

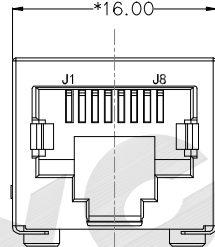

FRONT

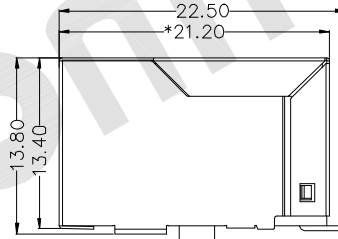

RIGHT SIDE

**Material:**  
 Insulator Material: LCP, UL94V-0, Black Shield: 0.20mm Thickness  
 Copper Alloy, Nickel Plated  
 Contact Material: Phosphor Bronze 0.35mm  
 Gold Plating: Selective Gold Plating Over Nickel: 3u", 6u", 15u", 30u"

**Mechanical:**  
 Durability: 750 Cycles Min  
 Matting Force: 22N Max

**Environmental:**  
 Storage Temperature : -40°C to +85°C  
 Operation Temperature: -40°C to +85°C

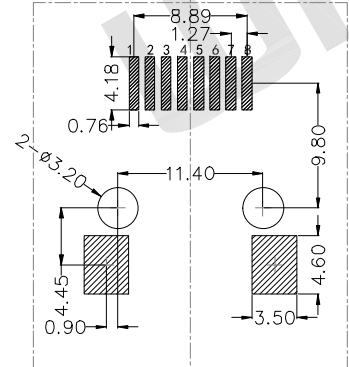

RECOMMENDED PCB LAYOUT

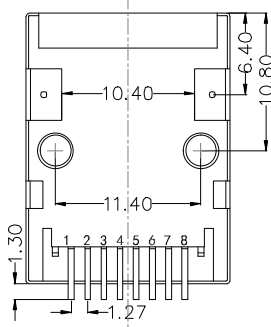

BOTTOM

MJT31 - M4 002 X X X X X X

Shield	Mounting	LED Color	Plastic Peg	Insulator	Gold Plating
0 - w/o Shield	1 - SMT	0 - w/o LED	1 - With	1 - PBT	1 - Fμ"
1 - Shield w/o EMI	2 - DIP	1 - Y/G	2 - Without	2 - PA66	2 - 3μ"
2 - Shield w/ EMI		2 - G/Y		3 - PA46	3 - 6μ"
3 - Half Shield		3 - G/G		4 - LCP	4 - 15μ"
		4 - Y/Y			5 - 30μ"
		5 - Special			6 - 50μ"

GENERAL TOLERANCE	ANGLE TOLERANCE	PROJECTION	TITLE	RJ45 MAGJACK, SMT TYPE, TAB-DOWN, 100BASE-T, SHIELDED
X. ±0.35	X. ±3.0°	mm		
.X ±0.30	.X ±2.0°			
.XX ±0.25	.XX ±1.5°			
.XXX ±0.10	.XX ±1.0°			
DRAWING TYPE	CUSTOMER	SHEET SIZE	PART NO.	MJT31 - M400211014X
SCALE	1:1	SHEET	1 OF 2	
SERIES	MJT31 SERIES			

## WAYCONN CO.,LTD

# Schematics

REV.	DESCRIPTION	DRAWN	CHECKED	APPROVED
A	NEW RELEASE		~	

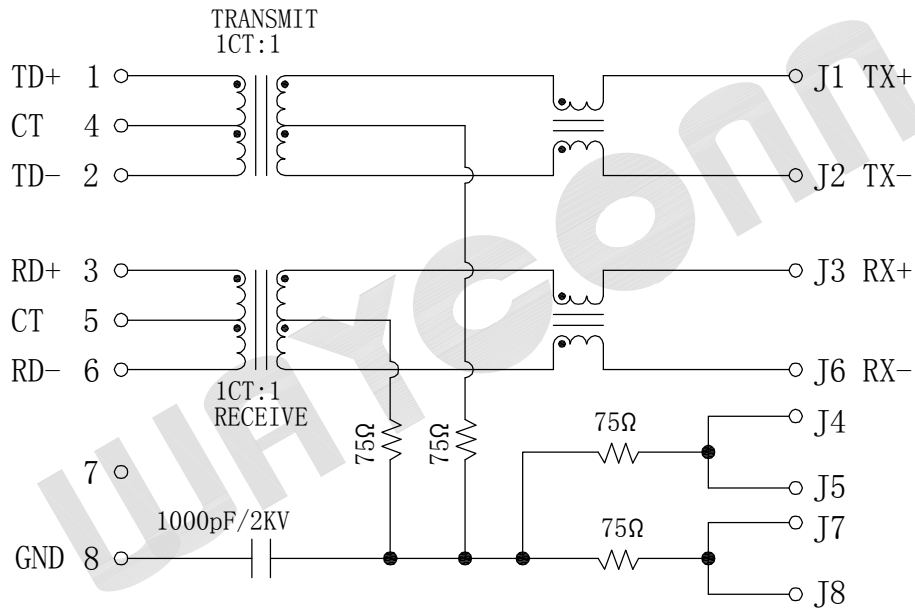

## ELECTRICAL SPECIFICATIONS AT 25°C

Turns Ratio (±2%)		Insertion Loss (dB max)		Return Loss (dB max)				Crosstalk (dB TYP)			Common Mode Rejection (dB TYP)	Hipot (vrms)
TX	RX	1~100 MHz	1~10 MHz	10~30 MHz	30~60 MHz	60~100 MHz	1~30 MHz	30~60 MHz	60~100 MHz	1~100 MHz		
1CT: 1CT	1CT: 1CT	-1.0	-20	-16	-12	-10	-40	-35	-30	-30	1500	

1. OCL: 350uH minimum with 8mA current;

GENERAL TOLERANCE	ANGLE TOLERANCE	PROJECTION	TITLE	RJ45 MAGJACK, SMT TYPE, TAB-DOWN, 100BASE-T, SHIELDED
X. ±0.35	X. ±3.0°	UNITS	mm	
.X ±0.30	.X ±2.0°	SHEET SIZE	A4	PART NO. MJT31 - M400211014X
.XX ±0.25	.XX ±1.5°	<b>WAYCONN CO.,LTD</b>		
.XXX ±0.10	.XX ±1.0°			
DRAWING TYPE	CUSTOMER			
SCALE	1:1	SHEET	2 OF 2	
SERIES	MJT31 SERIES			