

Mechanical

REV.	DESCRIPTION	DRAWN	CHECKED	APPROVED
A	NEW RELEASE		~	

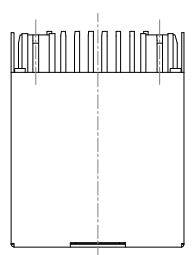

TOP VIEW

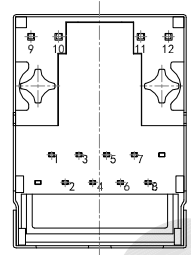

BACK VIEW

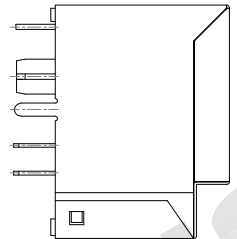

LEFT SIDE VIEW

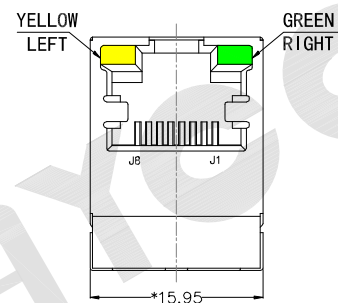

FRONT VIEW

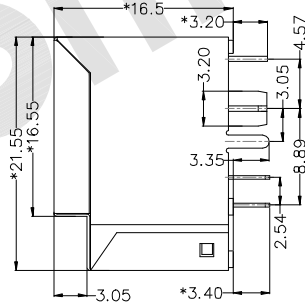

RIGHT SIDE VIEW

Material:
 Insulator Material: PBT+30%GF(Glass Filled), UL94V-0, Black
 Shield: 0.20mm Thickness Copper Alloy, Nickel Plated
 Contact Material: Phosphor Bronze 0.35mm
 Gold Plating: Selective Gold Plating Over Nickel: 3u", 6u", 15u", 30u"

Mechanical:
 Durability: 750 Cycles Min
 Matting Force: 22N Max

Environmental:
 Storage Temperature : -40°C to +85°C
 Operation Temperature: -40°C to +85°C

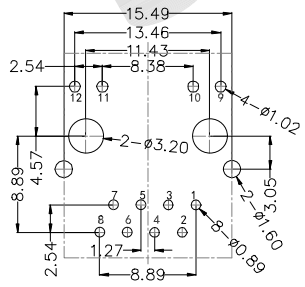

RECOMMENDED PCB LAYOUT VIEWED FROM COMPONENT SIDE

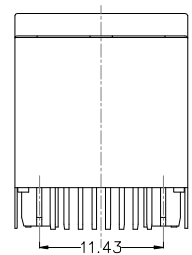

BOTTOM VIEW

MJT24 - M4 002 X X X X X X

Shield	No. of Ports	LED Color	Plastic Peg	Insulator	Gold Plating
0 - w/o Shield	1 - 1X1	0 - w/o LED	1 - Split	1 - PBT	1 - 1μ"
1 - Shield w/o EMI	2 - 1X2	1 - Y/G	2 - Cross	2 - PA66	2 - 3μ"
2 - Shield w/ EMI	4 - 1X4	2 - G/Y	3 - Half Round	3 - PA46	3 - 6μ"
3 - Half Shield	6 - 1X6	3 - G/G		4 - LCP	4 - 15μ"
	8 - 1X8	4 - Y/Y			5 - 30μ"
		5 - Special			6 - 50μ"

GENERAL TOLERANCE	ANGLE TOLERANCE
X. ±0.35	X. ±3.0°
.X ±0.30	.X ±2.0°
.XX ±0.25	.XX ±1.5°
.XXX ±0.10	.XX ±1.0°

PROJECTION	TITLE
mm	100BASE-T, TOP ENTRY, 180°, SHIELD W/ LED, W/ GAP
SHEET SIZE	PART NO.
A4	MJT24 - M4002112XX

DRAWING TYPE	CUSTOMER
SCALE	1:1 SHEET 2 OF 2
SERIES	MJT24 SERIES

WAYCONN CO.,LTD

Schematics

REV.	DESCRIPTION	DRAWN	CHECKED	APPROVED
A	NEW RELEASE		~	

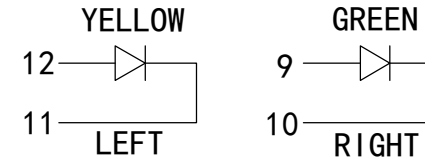
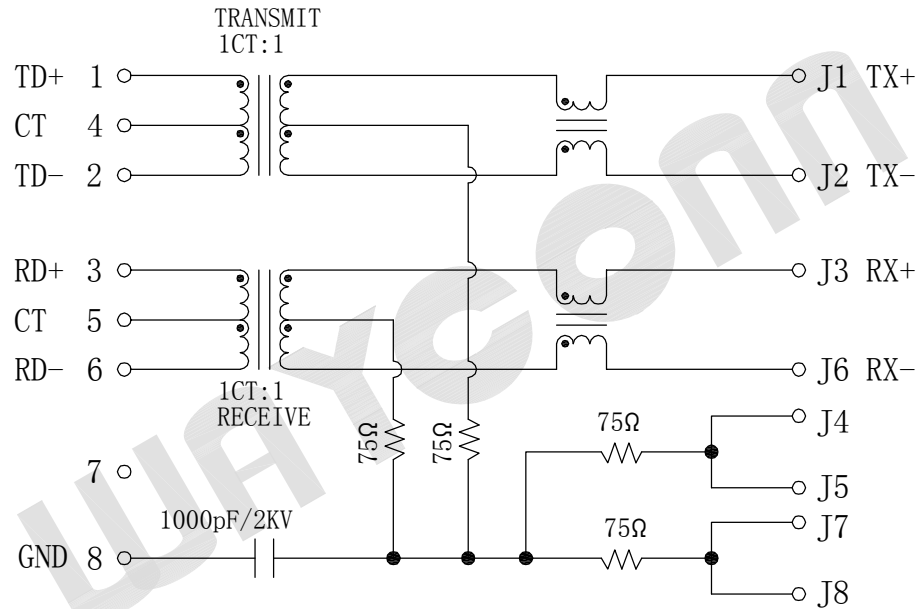

LED SPECIFICATIONS

Standard LED Color	LED Wavelength	Foward(A)	Foward(V)
Green	568nm	20mA	1.85-2.45V
Yellow	585nm	20mA	1.7-2.2V

ELECTRICAL SPECIFICATIONS AT 25°C

Turns Ratio (±2%)		Insertion Loss (dB max)		Return Loss (dB max)			Crosstalk (dB TYP)			Common Mode Rejection (dB TYP)	Hipot (vrms)
TX	RX	1~100 MHz	1~10 MHz	10~30 MHz	30~60 MHz	60~100 MHz	1~30 MHz	30~60 MHz	60~100 MHz	1~100 MHz	
1CT: 1CT	1CT: 1CT	-1.0	-20	-16	-12	-10	-40	-35	-30	-30	1500

1. OCL: 350uH minimum with 8mA current;

GENERAL TOLERANCE	ANGLE TOLERANCE	PROJECTION	TITLE	100BASE-T, TOP ENTRY, 180°, SHIELD W/ LED, W/ GAP
X. ±0.35	X. ±3.0°	mm		
.X ±0.30	.X ±2.0°			
.XX ±0.25	.XX ±1.5°	SHEET SIZE	PART NO.	MJT24 - M40021112XX
.XXX ±0.10	.XX ±1.0°	A4		
DRAWING TYPE	CUSTOMER	WAYCONN CO.,LTD		
SCALE	1:1 SHEET 2 OF 2			
SERIES	MJT24 SERIES			