

Mechanical

REV.	DESCRIPTION	DRAWN	CHECKED	APPROVED
A	NEW RELEASE		~	

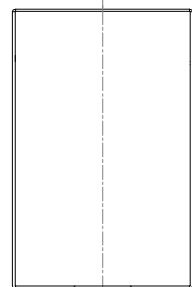

TOP

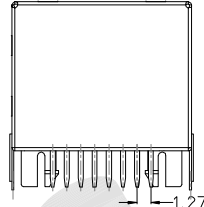

BACK

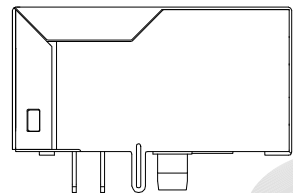

LEFT SIDE

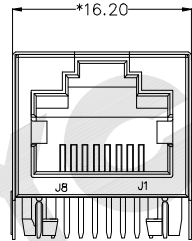

FRONT

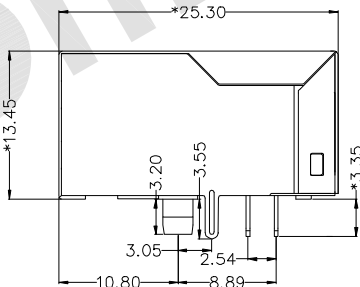

RIGHT SIDE

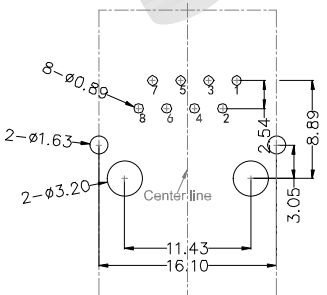

RECOMMENDED PCB LAYOUT

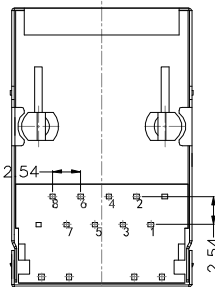

BOTTOM

Material:

Insulator Material: PBT+30%GF(Glass Filled), UL94V-0, Black
 Shield: 0.20mm Thickness Copper Alloy, Nickel Plated
 Contact Material: Phosphor Bronze 0.35mm
 Gold Plating: Selective Gold Plating Over Nickel: 3u", 6u", 15u", 30u"

Mechanical:

Durability: 750 Cycles Min
 Matting Force: 22N Max

Environmental:

Storage Temperature : -40°C to +85°C
 Operation Temperature: -40°C to +85°C

MJT13 - M4 075 X X X X X X

Shield	No. of Ports	LED Color	Plastic Peg	Insulator	Gold Plating
0 - w/o Shield	1 - 1X1	0 - w/o LED	1 - Split	1 - PBT	1 - Fμ"
1 - Shield w/o EMI	2 - 1X2	1 - Y/G	2 - Cross	2 - PA66	2 - 3μ"
2 - Shield w/ EMI	4 - 1X4	2 - G/Y		3 - PA46	3 - 6μ"
3 - Half Shield	6 - 1X6	3 - G/G		4 - LCP	4 - 15μ"
	8 - 1X8	4 - Y/Y			5 - 30μ"
		5 - Special			6 - 50μ"

GENERAL TOLERANCE	ANGLE TOLERANCE	PROJECTION	TITLE
X. ±0.35	X. ±3.0°		TAB-UP, 100BASE-T, SHIELD, L: 25.3MM
.X ±0.30	.X ±2.0°	mm	
.XX ±0.25	.XX ±1.5°		PART NO. MJT13 - M40751101XX
.XXX ±0.10	.XX ±1.0°		
DRAWING TYPE CUSTOMER		<h1>WAYCONN CO.,LTD</h1>	
SCALE	1:1 SHEET 2 OF 2		
SERIES	MJT13 SERIES		

Schematics

REV.	DESCRIPTION	DRAWN	CHECKED	APPROVED
A	NEW RELEASE		~	

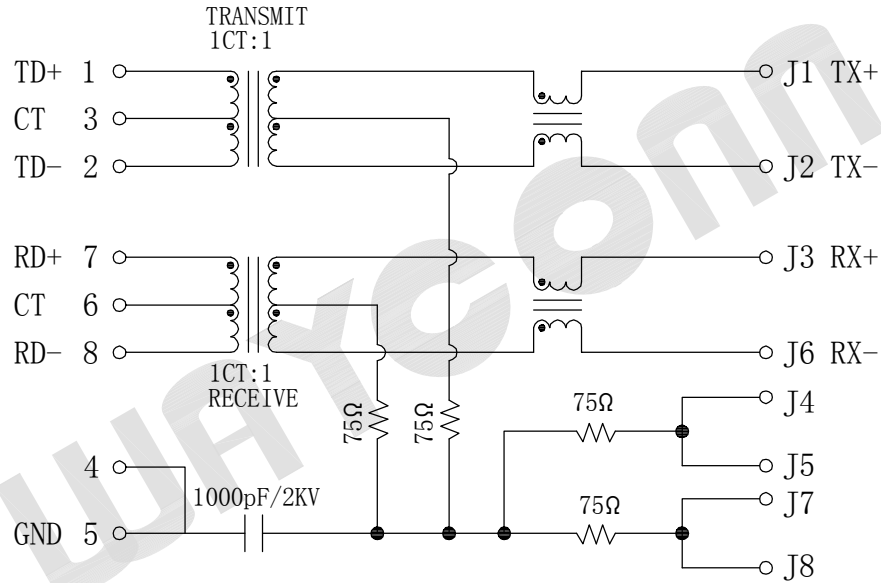

ELECTRICAL SPECIFICATIONS AT 25°C

Turns Ratio (±2%)		Insertion Loss (dB max)		Return Loss (dB max)					Crosstalk (dB TYP)			Common Mode Rejection (dB TYP)	Hipot (vrms)
TX	RX	1~100 MHz	1~10 MHz	10~30 MHz	30~60 MHz	60~100 MHz	1~30 MHz	30~60 MHz	60~100 MHz	1~100 MHz			
1CT: 1CT	1CT: 1CT	-1.0	-20	-16	-12	-10	-40	-35	-30	-30	1500		

1. OCL: 350uH minimum with 8mA current;

GENERAL TOLERANCE	ANGLE TOLERANCE	PROJECTION		TITLE	TAB-UP, 100BASE-T, SHIELD, L: 25.3MM
X. ±0.35	X. ±3.0°	UNITS	mm	PART NO.	MJT13 - M40751101XX
.X ±0.30	.X ±2.0°	<h1>WAYCONN CO.,LTD</h1>			
.XX ±0.25	.XX ±1.5°				
.XXX ±0.10	.XX ±1.0°				
DRAWING TYPE	CUSTOMER				
SCALE	1:1	SHEET	2 OF 2		
SERIES	MJT13 SERIES				