

Mechanical

REV.	DESCRIPTION	DRAWN	CHECKED	APPROVED
A	NEW RELEASE		~	

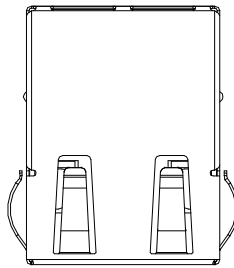

TOP

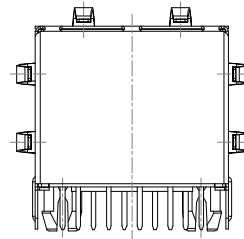

BACK

Material:

Insulator Material: PBT+30%GF(Glass Filled), UL94V-0, Black
 Shield: 0.20mm Thickness Copper Alloy, Nickel Plated

Contact Material: Phosphor Bronze 0.35mm

Gold Plating: Selective Gold Plating Over Nickel: 3u", 6u", 15u", 30u"

Mechanical:

Durability: 750 Cycles Min

Matting Force: 22N Max

Environmental:

Storage Temperature : -40°C to +85°C

Operation Temperature: -40°C to +85°C

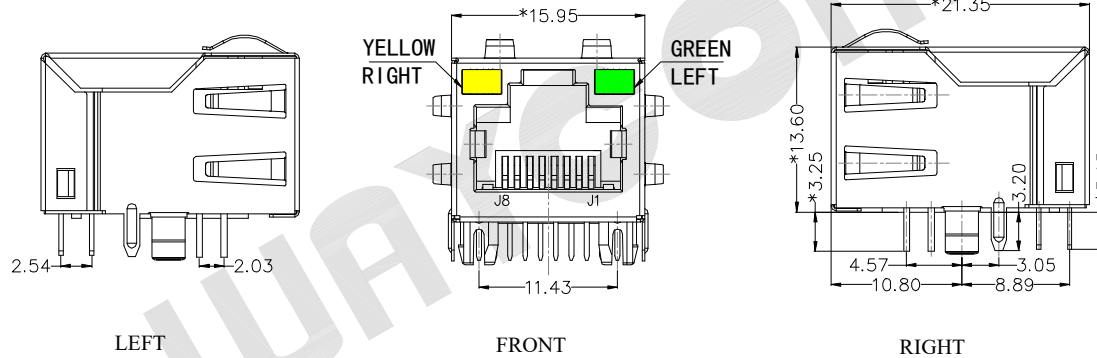

LEFT

FRONT

RIGHT

MJT12 - G8 066 X X X X X X

Shield	No. of Ports	LED Color	Plastic Peg	Insulator	Gold Plating
0 - w/o Shield	1 - 1X1	0 - w/o LED	1 - Split	1 - PBT	1 - Fμ"
1 - Shield w/o EMI	2 - 1X2	1 - Y/G	2 - Cross	2 - PA66	2 - 3μ"
2 - Shield w/ EMI	4 - 1X4	2 - G/Y		3 - PA46	3 - 6μ"
3 - Half Shield	6 - 1X6	3 - G/G		4 - LCP	4 - 15μ"
	8 - 1X8	4 - Y/Y			5 - 30μ"
		5 - Special			6 - 50μ"

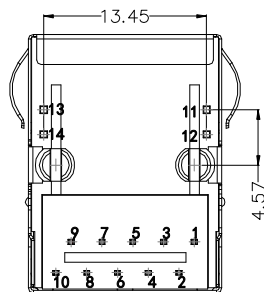

RECOMMENDED PCB LAYOUT

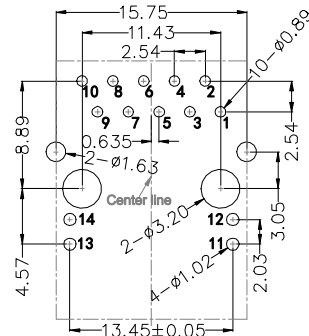

BOTTOM

GENERAL TOLERANCE		ANGLE TOLERANCE	
X.	±0.35	X.	±3.0°
.X	±0.30	.X	±2.0°
.XX	±0.25	.XX	±1.5°
.XXX	±0.10	.XX	±1.0°

PROJECTION		TITLE	RJ45 MAGJACK, TAB-UP
UNITS	mm		1000BASE, SHIELD W/ EMI & LED
SHEET SIZE	A4	PART NO.	MJT12 - G8066211XX

DRAWING TYPE	CUSTOMER		
SCALE	1:1	SHEET	2 OF 2
SERIES	MJT12 SERIES		

WAYCONN CO.,LTD

Schematics

REV.	DESCRIPTION	DRAWN	CHECKED	APPROVED
A	NEW RELEASE		~	

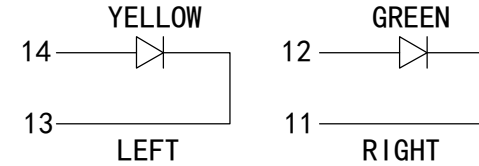
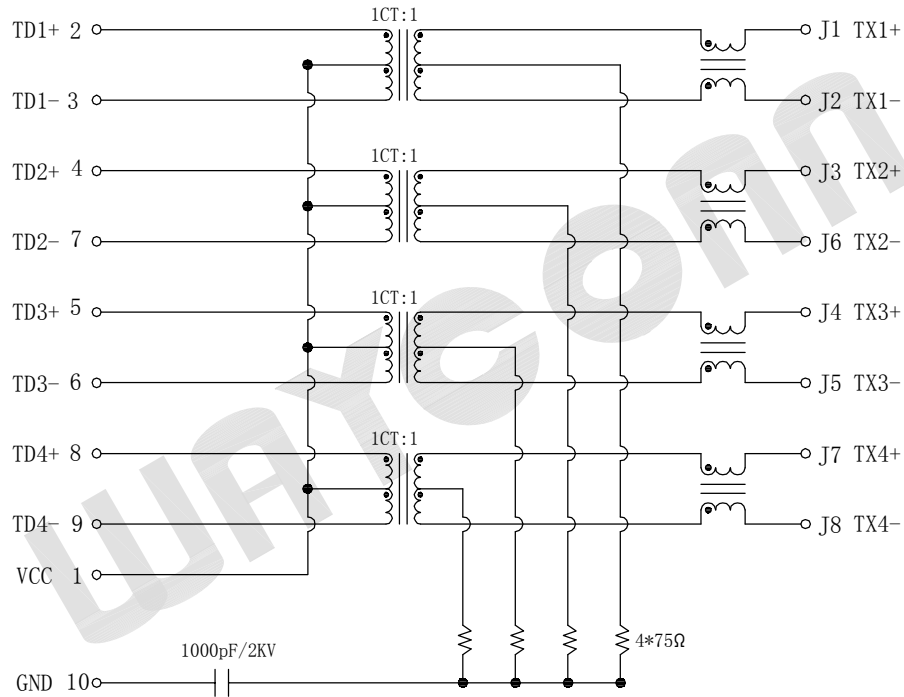

LED Specification

Standard LED Color	LED Wavelength	Foward(A)	Foward(V)
Green	568nm	20mA	1.85-2.45V
Yellow	585nm	20mA	1.7-2.2V

ELECTRICAL SPECIFICATIONS AT 25°C

Turns Ratio (±2%)		Insertion Loss (dB max)	Return Loss (dB max)				Crosstalk (dB TYP)			Common Mode Rejection (dB TYP)	Hipot (vrms)
TX	RX		1~100 MHz	1~10 MHz	10~30 MHz	30~60 MHz	60~100 MHz	1~30 MHz	30~60 MHz		
1CT: 1CT	1CT: 1CT	-1.0	-20	-16	-12	-10	-40	-35	-30	-30	1500

1. OCL: 350uH minimum with 8mA current;

GENERAL TOLERANCE	ANGLE TOLERANCE	PROJECTION	TITLE	RJ45 MAGJACK, TAB-UP
X. ±0.35	X. ±3.0°	mm		1000BASE, SHIELD W/ EMI & LED
.X ±0.30	.X ±2.0°			
.XX ±0.25	.XX ±1.5°	SHEET SIZE	PART NO.	MJT12 - G80662111XX
.XXX ±0.10	.XX ±1.0°	A4		
DRAWING TYPE	CUSTOMER	WAYCONN CO.,LTD		
SCALE	1:1 SHEET 2 OF 2			
SERIES	MJT12 SERIES			